

Door blank with Compact Laminate / 55 mm stiles and rails / 4 mm SBD

Facing: 4 mm Compact laminate on cross banded plywood with 0,3 mm aluminium
Stiles: 55 mm finger joint pine timber
Rails: 55 mm finger joint pine timber
Core: Polystyrene insulation + 2x4 mm plywood SBD

U-Value:

U-Value - W/m²K									
60 mm	68 mm								
0,80	0,71								

Heat conductivity is calculated on the basis of the practical heat conductivity of each included material - taken from data sheets and DS418:2011

Weight:

Weight appr. Kg./m²									
60 mm	68 mm								
24,3	25,2								

Size 1000 x 2000 mm.

Performance:

	Classification standards	Performance
Operating Forces	EN12217	Class 5
Climatic Influences	EN12219	Class 3
Security	EN1627 / EN1628-30	N/A
Sound	EN10140-2	22 dB
Fire	EN13501-2 / EN1634-1	N/A
FSC Certified	FSC-STD-40-004 V2-1/FSC-STD-50-001 V1-2	N/A

General tests has been carried out on a 68 mm. door blank with chen-chen veneer.
 Sound tests has been carried out on a 60 mm. door blank with chen-chen veneer.
 Size 1000 x 2100 mm. Stiles and rails 55 mm.

Measure: Min.: 250 x 450 mm - Max.: 1200 x 2400 mm

Tolerances:

Door blank: Width/Height: +/- 1 mm - Diagonal: +/- 2 mm - Thickness: +/- 0,8 mm
 Facing: Measurements on facing is before final sanding
 Stiles and rails: Width: +/- 2 mm
 Core: Inserts: +/- 1 mm on plywood

Elevation and section drawing:

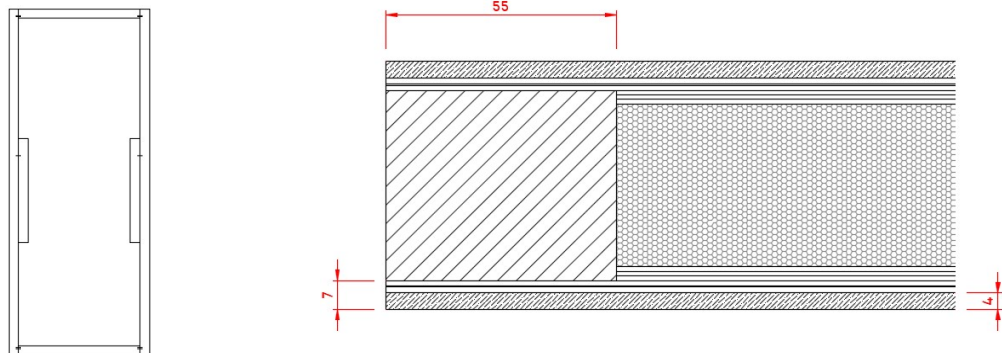

Stiles and rails: Front perspective

Made: 23.06.2021	Data sheet: CRS	Draw.: HMN
Revised: 01.12.2021	Data sheet: CRS	Draw.: CRS